

SBX 1620

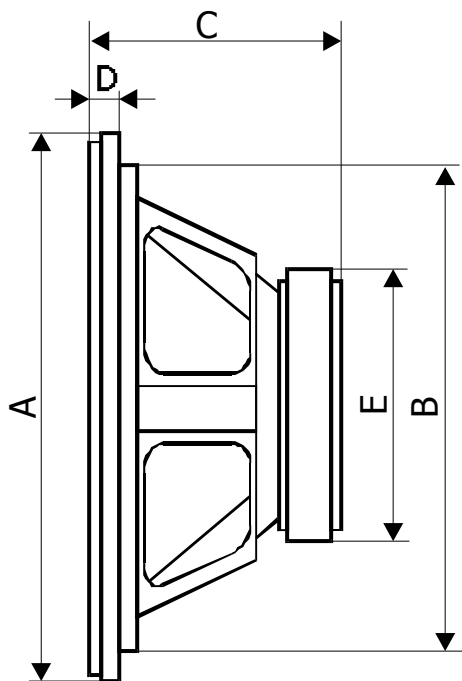

A	Külső átmérő Diameter Durchmesser	167 mm
B	Beépítési átmérő Mounting cutout Einbauöffnung	145 mm
C	Beépítési mélység Mounting depth Einbautiefe	82 mm
D	Perem vastagság Edge width Randstreifen	8 mm
E	Mágnes átmérő Magnet diameter Magnetdurchmesser	100 mm